



<b>Bezeichnung</b>	GigE Vision
<b>Scan-Typ</b>	Scannen von Bereichen
<b>Schnittstelle</b>	GigE
<b>Auflösung 1</b>	0,4 MP, 1,3 MP, 1,6 MP, 2,0 MP, 2,3 MP, 3,1 MP, 4,0 MP, 5,0 MP, 8,3 MP, 10,0 MP, 12,0 MP
<b>Auflösung 2</b>	720 x 540, 1280 x 1024, 1440 x 1080, 1920 x 1200, 2048 x 1088, 2048 x 1536, 2048 x 2048, 2448 x 2048, 2592 x 1944, 3840 x 2160, 4000 x 3000
<b>Verschlusszeit</b>	Global, Rolling-Shutter-Effekt
<b>Chipgröße</b>	1", 1/1.2", 1/1.7", 1/1.8", 1/2.3", 1/2.5", 1/2.9", 2/3"
<b>Pixelgröße (µm)</b>	1,62 x 1,62, 1,67 x 1,67, 1,85 x 1,85, 2,2 x 2,2, 3,45 x 3,45, 5,3 x 5,3, 5,5 x 5,5, 5,86 x 5,86, 6,9 x 6,9
<b>Max. Bildfrequenz</b>	8,7 fps bis 265 fps
<b>Sensorhersteller</b>	Aptina, CMOSIS, eV2, Sony
<b>Kameratyp</b>	Farbe, Monochrom, NIR

**OMRON**

## Industrial Cameras

3Z4S-CA Series





<p><b>How to Choose a camera</b>  <b>Camera Line-up Chart</b></p>		<p>Per-interface comparison table          Camera Line-up Chart</p>	<p>P3-4</p>	<p>How to Choose a camera</p>
<p><b>GigE Vision</b></p>		<p> CMOS Series</p>	<p>P5-6</p>	<p>GigE</p>
<p><b>USB</b></p>		<p> USB3.0</p>	<p>P7-10</p>	<p>USB</p>
<p><b>CameraLink Over</b></p>		<p> CoaXPRESS</p>	<p>P13-14</p>	<p>CameraLink Over</p>
<p><b>CameraLink</b></p>		<p> CMOS Series</p>	<p>P17-22</p>	<p>CameraLink</p>
<p><b>DVI/SDI</b></p>		<p> DVI Series</p>	<p>P23-24</p>	<p>DVI/SDI</p>
<p><b>Color TV Format</b></p>		<p> S133 Series</p>	<p>P27-28</p>	<p>Color TV Format</p>
<p><b>Line Scanning Camera</b></p>		<p> CameraLink Series</p>	<p>P29-34</p>	<p>Line Scanning Camera</p>
<p><b>Accessories</b></p>		<p> Cable, Others</p>	<p>P35-36</p>	<p>Accessories</p>
		<p>Spectral Sensitivity Characteristics</p>	<p>P37-44</p>	



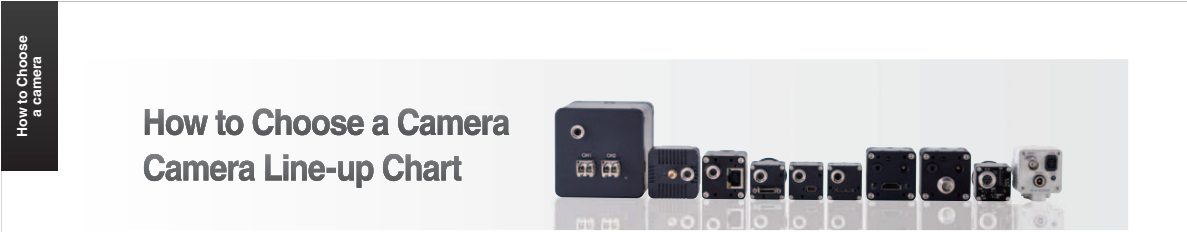

How to Choose a camera

## How to Choose a Camera Camera Line-up Chart

### How to Choose an Image Sensor

- Monochrome  
→ Mono or Color?
- Number of Pixels  
→ Optimal Resolution for Your Application
- Scan Speed  
→ Required FPS
- Sensor Size?

### How to Choose the Interface

- Connect to  
→ Monitor or PC?
- Cable Length  
→ Distance Between the Camera and the Equipment
- The Number of Cameras  
→ How many cameras for one PC?

Based on factors such as decided specifications, system outline and cost image, refer to the following per-interface comparison table and product lineup chart to choose the optimum Sentech camera.

■ Interface when using a PC / ■ Interface when not using a PC / ■ Interface not offered by OMRON

Interfaces	GigE Vision®	USB		CoaXpress	Opt-C.Link	Camera Link		Analog	HD-DVI	HD-SDI	TV Formats	IEEE1394b	Camera Link HS
		USB2.0	USB3.0			Base	Full						
Monitor Display		PC Required				PC Required			Can be connected directly to monitor			PC Required	PC Required
Connection Port	Gigabit Ethernet Port	USB2.0 Port	USB3.0 Port	CoaXpress Grabber Board	Opt-C.Link Grabber Board	Camera Link Frame Grabber Board		Analog Frame Grabber Board	HDMI Port DVI Port	SDI connector	RCA connector BNC connector	Required	CameraLink HS Grabber Board
Cable	Ethernet cable Cat 5e or higher	USB2.0 Cable	USB3.0 Cable	Coaxial Cable	Optical cable	Camera Link Cable		12-pin Cable	HDMI/DVI Cable	Coaxial Cable for SDI	Coaxial Cable	IEEE1394b Cable	Camera LinkHS Cable
Max. Cable Length	100m	5m	3m	25m	150m	Approx. 5m to 12m		100m	5m	100m	100m	100m	15m
Image Transmission Capacity	☆☆	☆	☆☆☆	☆☆☆☆	☆☆☆☆☆	☆☆	☆☆☆☆	☆☆	☆☆	☆☆	☆	☆☆	☆☆
Max. Transmission Speed	122 fps 30 Megapixel -15 fps 500 Megapixel(1,000Mbps)	90 fps 30 Megapixel -15 fps 200 Megapixel(480Mbps)	123 fps 30 Megapixel -14 fps 500 Megapixel(5,000Mbps)	25Gbps	12.5Gbps	240 fps 30 Megapixel -16 fps 500 Megapixel(2,380Mbps)	600 fps 30 Megapixel -60 fps 1200 Megapixel(7,140Mbps)	90 fps 30 Megapixel - 15 fps 200 Megapixel	60fps1080p	60fps1080p	59.94 fps 30 Megapixel (interfaced)	800Mbps	2,100Mbps
Power over Cable	○(PoE Model)	○(All Models)		○	-	○(PoCL Model)		Separate Power Supply	Separate Power Supply	Separate Power Supply	Separate Power Supply	○	○
Software Provider	Camera Manufacturer	Camera Manufacturer		Board Manufacturer	Board Manufacturer	Board Manufacturer		Board Manufacturer	Not required			Camera Manufacturer	Board Manufacturer
System Cost	Low	Low		High	High	High		High	Low	Mid	Low	Low	High
Multiple Device Connection	Add Ethernet card or use switching hub	Add USB port expansion card (hub not recommended)		Add frame grabber board	Add frame grabber board	Add frame grabber board		Add frame grabber board	Use switcher			IEEE1394b expansion card, use hub	Add frame grabber board
Advantages	- Long cable length - Cheap cost to connect multiple cameras - Frame grabber not required	- Easy to connect - Low cost - Cheap cost to connect multiple cameras		- Long cable length - High transmission capacity	- Long cable length - Strong to noise	- Proven track record - High transmission capacity		- Proven track record - Long cable length	- Can easily be connected directly to monitor	- Long cable length	- Proven track record - Low cost - Long cable length	- Proven track record	- High transmission capacity - Smaller connector compared with Camera Link
Disadvantages	- Lower fps comparing with other interfaces	- Short cable length		- No extensive track record - High board cost	- No extensive track record - Few compatible board	- Short cable length - High board and cable cost - High cost to connect multiple cameras		- High board and cable cost	- Short cable length - No trigger function	- Few SDI-compatible monitors	- Low resolution	- Short cable length - IEEE1394b card required	- High board and cable cost
Main Applications	- Image processing - Monitoring	- Image processing - Monitoring		- Image processing - Monitoring	- Image processing - Monitoring	- Image processing		- Image processing	- Monitoring		- Image processing - Monitoring	- Image processing	- Image processing

\*System costs, advantages and disadvantages are subjective opinions by OMRON

How to Choose  
a camera



## GigE Vision CMOS Series

GigE



### Description

High resolution, high speed CMOS sensors adopted PoE compatible GigE camera

### Features

Sony CMOS [Pregius] adopted cameras are also available

### Product Line-up

Model	Monochrome	STC-SBS43POE	STC-SBE132POE	STC-SBS163POE	STC-CMB2MPOE	STC-SBS231POE	STC-SBS312POE
	Color	STC-SCS43POE	STC-SCE132POE	STC-SCS163POE	STC-CMC2MPOE	STC-SCS231POE	STC-SCS312POE
	NIR				STC-CMB2MPOE-IR		
Resolution		0.4M	1.3M	1.6M	2M	2.3M	3.2M
Frame Rate		265fps	61fps	69fps	50fps	41.6fps	33.3fps
Effective Pixels		728 × 544	1280 × 1024	1456 × 1088	2048 × 1088	1920 × 1200	2048 × 1536
Sensor Size		1/2.9	1/1.8	1/2.9	2/3	1/1.2	1/1.8
Cell Size(HxV, μm)		6.9 × 6.9	5.3 × 5.3	3.45 × 3.45	5.5 × 5.5	5.86 × 5.86	3.45 × 3.45
Sensor		IMX287	EV76C560	IMX273	CMV2000	IMX249	IMX265
Lens Mount		C	C	C	C	C	C
General Specifications							

Model	Monochrome	STC-CMB4MPOE	STC-SBS500POE	STC-SBA503POE		STC-SBA1002POE	STC-SBS1242POE
	Color	STC-CMC4MPOE	STC-SCS500POE	STC-SCA503POE	STC-SCS853POE		STC-SCS1242POE
	NIR	STC-CMB4MPOE-IR					
Resolution		4M	5M	5M	8.3M	10M	12M
Frame Rate		25fps	21fps	14fps	12.7fps	10.4fps	8.7fps
Effective Pixels		2048 × 2048	2448 × 2048	2592 × 1944	3840 × 2160	3856 × 2764	4000 × 3000
Sensor Size		1	2/3	1/2.5	1/2.5	1/2.3	1/1.7
Cell Size(HxV, μm)		5.5 × 5.5	3.45 × 3.45	2.2 × 2.2	1.62 × 1.62	1.67 × 1.67	1.85 × 1.85
Sensor		CMV4000	IMX264	MT9P031	IMX274	MT9J003	IMX226
Lens Mount		C	C	C	C	C	C
General Specifications				Rolling Shutter	Rolling Shutter	Rolling Shutter	Rolling Shutter

\* STC-SBS/SCS43POE, STC-SBS/SCS163POE are scheduled to be released in December.

**External Connector's Specification**

External Connectors	Ethernet: RJ45, Power Supply I/O: HR10A-7R-6PB (Hirose)
---------------------	---

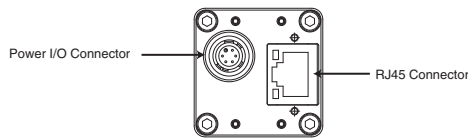

- ▶ HR10A-7R-6PB (Hirose) or equivalent
- ▶ This connector supplies both power (12V DC) and input / output signals
- ▶ Please use HR10A-7P -6S (Hirose) or equivalent for the cable

**Pin Assignments**

Pin No.	Description	I/O	Signal Voltage
1	GND	IN	0V
2	Output1	OUT	Open Collector
3	Output2	OUT	Open Collector
4	TRG In- Opt.Isolated-	IN	Low: Smaller than +1.0V High: +3.0 to +26.4V
5	TRG In+ Opt.Isolated+	IN	*Potential difference between TRG_In- and TRG_In+
6	Power in	IN	+10.8 to 26.4 Vdc

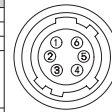

- ▶ Output 1 and Output 2 can be assigned by the communication (Device Code=00H, Command=F0H and F1H)

GigE

**Drawing dimension**

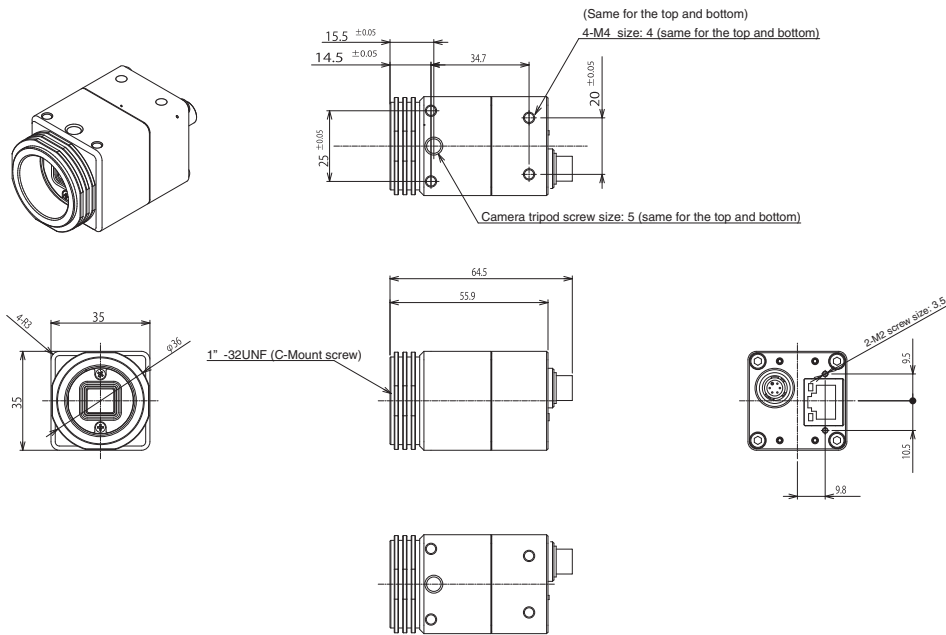

\* Drawings are differed by camera type. Please contact us.

## USB3.0 Series



### Description

USB3.0 Compact CMOS Camera

### Features

Sony CMOS [Pregius] adopted cameras are lined up  
High resolution-high speed CMOS sensors adopted  
Compact, robust and easy to attach

USB

### Product Line-up

Model	monochrome	STC-MBS43U3V	STC-MBE132U3V	STC-MBS163U3V	STC-MBCM200U3V	STC-MBS231U3V	STC-MBS241U3V
	Color	STC-MCS43U3V	STC-MCE132U3V	STC-MCS163U3V	STC-MCCM200U3V	STC-MCS231U3V	STC-MCS241U3V
	NIR				STC-MBCM200U3V-NIR		
Resolution		0.4M	1.3M	1.6M	2M	2.3M	2.3M
Frame Rate		527.1fps	60fps	238.0fps	167fps	41.6fps	163fps
Effective Pixels		720 × 540	1280 × 1024	1440 × 1080	2048 × 1088	1920 × 1200	1920 × 1200
Sensor Size		1/2.9	1/1.8	1/2.9	2/3	1/1.2	1/1.2
Cell Size(HxV, μm)		6.9 × 6.9	5.3 × 5.3	3.45 × 3.45	5.5 × 5.5	5.86 × 5.86	5.86 × 5.86
Sensor		IMX287	EV76C560	IMX273	CMV2000	IMX249	IMX174
Lens Mount		C	CS	C	C	C	C
General Specifications		USB3Vision Available	USB3Vision Available	USB3Vision Available	USB3Vision Available	USB3Vision Available	USB3Vision Available

Model	monochrome	STC-MBS312U3V	STC-MBS322U3V	STC-MBCM401U3V	STC-MBS500U3V	STC-MBS510U3V	STC-MBA5MUSB3
	Color	STC-MCS312U3V	STC-MCS322U3V	STC-MCCM401U3V	STC-MCS500U3V	STC-MCS510U3V	STC-MCA5MUSB3
	NIR			STC-MBCM401U3V-NIR			
Resolution		3.2M	3.2M	4M	5M	5M	5M
Frame Rate		56fps	121fps	89fps	35.8fps	75.7fps	14fps
Effective Pixels		2048 × 1536	2048 × 1536	2048 × 2048	2448 × 2048	2448 × 2048	2592 × 1944
Sensor Size		1/1.8	1/1.8	1	2/3	2/3	1/2.5
Cell Size(HxV, μm)		3.45 × 3.45	3.45 × 3.45	5.5 × 5.5	3.45 × 3.45	3.45 × 3.45	2.2 × 2.2
Sensor		IMX265	IMX252	CMV4000	IMX264	IMX250	MT9P031
Lens Mount		C	C	C	C	C	CS
General Specifications		USB3Vision Available	USB3Vision Available	USB3Vision Available	USB3Vision Available	USB3Vision Available	Rolling Shutter, USB3 Vision not available

Model	monochrome	STC-MBS881U3V	STC-MBS891U3V	STC-MBS122BU3V	STC-MBS123BU3V
	Color	STC-MCS881U3V	STC-MCS891U3V	STC-MCS122BU3V	STC-MCS123BU3V
	NIR				
Resolution		8.9M	8.9M	12M	12M
Frame Rate		32.2fps	42.3fps	23.4fps	30.5fps
Effective Pixels		4096 × 2160	4096 × 2160	4096 × 3000	4096 × 3000
Sensor Size		1	1	1.1	1.1
Cell Size(HxV, μm)		3.45 × 3.45	3.45 × 3.45	3.45 × 3.45	3.45 × 3.45
Sensor		IMX267	IMX255	IMX304	IMX253
Lens Mount		C	C	C	C
General Specifications		USB3Vision Available	USB3Vision Available	USB3Vision Available	USB3Vision Available

\* 8.9M, 12M cameras may not have sufficient supply power with USB bus supply only depending on PC spec. We recommend you to use external power.



**Accessories**

Screw Lock USB3.0 Cables		
Model	Applicable Model	Specification
NU3MBASU3S-2m	All USB3.0 Cameras	2m,USB3.0 MicroB,wish camera-side fastening screws
NU3MBASU3S-3.5m	All USB3.0 Cameras	3.5m,USB3.0 MicroB,wish camera-side fastening screws
NU3MBASU3B-2m	All USB3.0 Cameras	2m,USB3.0 MicroB,wish camera-side fastening screws,robot cables
NU3MBASU3B-3.5m	All USB3.0 Cameras	3.5m,USB3.0 MicroB,wish camera-side fastening screws,robot cables

\*Please make sure that USB 3.0 cables operate correctly under your environment beforehand

CS to C-Mount Conversion Adapter		
Item No.	Applicable Model	Specification
CS-C-R	CS Mount Series	

Tripod Mount		
Item No.	Relevant Cameras	Specification
TP-JVA	Except for STC-MCEM8E132U3V, STC-MBA/MCASMUS3	

**External Connector Specification**

External Connector	USB: USB3.0 MicroB type, I/O signals: HR10A-7R-6PB(Hirose) or equivalent
--------------------	--

- ▶ This connector is for the output signal, not for the power of the camera. The camera power is supplied in +5V from the USB cable  
It does not affect the voltage for the input signal

**Pin Assignment**

Pin No.	Signal Name	I/O	Signal Voltage	
			Low	High
1	GND for I/O signal	-	0V	
2	Output 2(I/O3)	OUT	0.8V or lower	+3.3 - +24V
3	Output 1(I/O2)	OUT	0.8V or lower	+3.3 - +24V
4	Input 2(I/O1)	IN	0.7V or lower	+2.5 - +5V
5	Input 1(I/O0)	IN	0.7V or lower	+2.5 - +5V
6	Power supply for output signal (IO_VCC)	-	+3.3 to +24 Vdc	

\*Example shown for reference

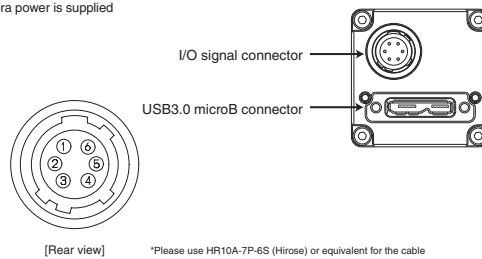

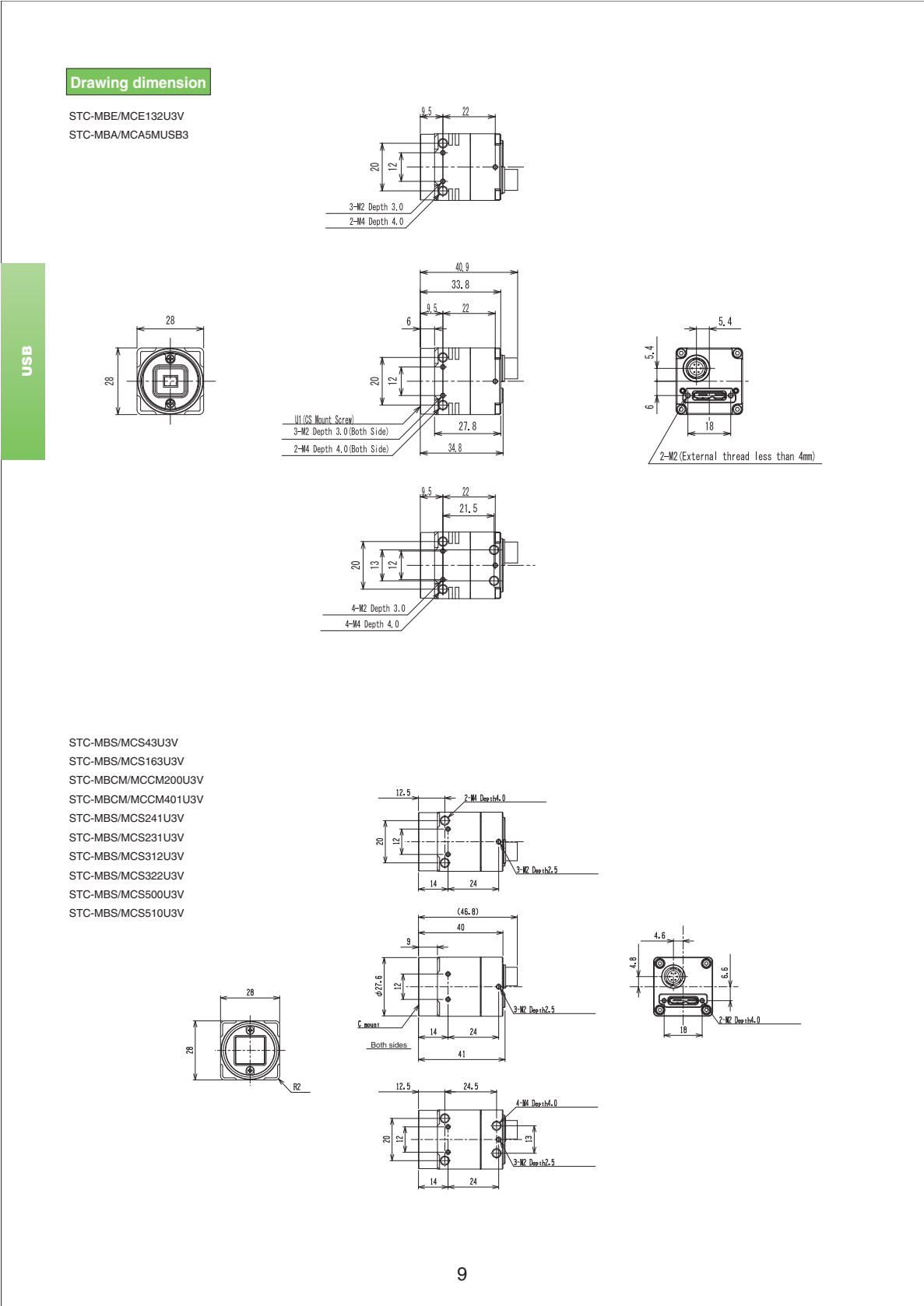



**USB3.0 Small CMOS camera S133 Series**



**Description**

CMOS Camera  
Small Color Camera

**Features**

Plug & Play USB camera

USB

**Product Line-up**

Model	Color	STC-S133UVC-*
Resolution		1.3M
Frame Rate		60/30fps
Effective Pixels		1280 × 720 / 1280 × 960
Sensor Size		1/3.2
Cell Size(HxV, μm)		3.5 × 3.5
Sensor		ISX017

\*Please select one among above when you order

**Line-up**

Model	Monochrome/Color	Sensor Size	Mount
STC-S133UVC-BL	Color	1/3.2	Base(Without lens mount)
STC-S133UVC-BLL			Fixed Lens
STC-S133UVC-BLCS			CS

\*STC-S133UVC Series are scheduled to be released in December.





## CoaxPress



### Description

High Speed CMOS CoaxPress Camera

### Features

4M, 12M  
High speed (186fps at 12M pixel)  
Light angle type also available

Camera Link Over

### Product Line-up

Model No.	Monochrome	STC-CMB401CXP	STC-CMB120ACXP	STC-CMB120ACXP-T	STC-CMB120ACXP-F	STC-CMB120ACXP-T-F
	Color	STC-CMC401CXP	STC-CMC120ACXP	STC-CMC120ACXP-T	STC-CMC120ACXP-F	STC-CMC120ACXP-T-F
Resolution		4M	12M	12M	12M	12M
Frame Rate		142.5fps	186fps	186fps	186fps	186fps
Effective Pixels		2048 × 2048	4096 × 3072	4096 × 3072	4096 × 3072	4096 × 3072
Sensor Size		1	1.76	1.76	1.76	1.76
Cell Size (HxV, μm)		5.5 × 5.5	5.5 × 5.5	5.5 × 5.5	5.5 × 5.5	5.5 × 5.5
Sensor		CMV4000	CMV12000	CMV12000	CMV12000	CMV12000
Lens Mount		C	M42 P=1 FB=10mm	M42 P=1 FB=10mm	F	F
General Specifications		PoCXP Compatibility, 1Lane	PoCXP Compatibility, 4Lane, Connector from rear	PoCXP Compatibility, 4Lane, Connector from Upside	PoCXP Compatibility, 4Lane, Connector from rear	PoCXP Compatibility, 4Lane, Connector from upside

\*CoaxPress Series are scheduled to be released in December.

### Accessories

Mount Conversion Adapter		
Model No.	Supported Models	General Specifications
M42-F-R	12M Model	M42 P=1 FB=10mm → Fmount Conversion Adapter

**External Connector Specification**

HR10A-7R-6PB (Hirose) or equivalent

The connector for the trigger signal output  
Trigger input available by changing camera setting  
Please use the HR10A-7P-6S (Hirose) or equivalent for the cable

2.3.1 Pin Asshments

Pin No.	Signal Name	I/O
1	IO_GND	-
2	GPIO2	IN/OUT
3	GPIO1	IN/OUT
4	GPIO0	IN/OUT
5	N.C.	-
6	N.C.	-



\*GPIO0, GPIO1, GPIO2 maximum rated voltage that can be applied to will be 24V  
\*N.C. terminal, please use as electrically OPEN

**Drawing dimension**

STC-CMB/CMC120ACXP-T

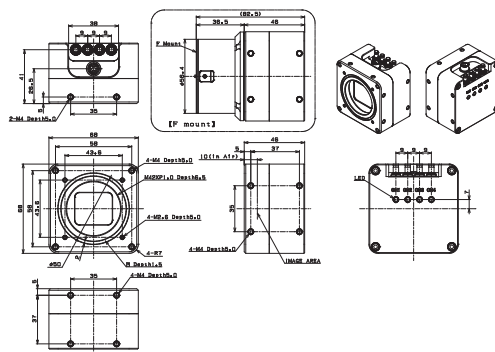

STC-CMB/CMC120ACXP

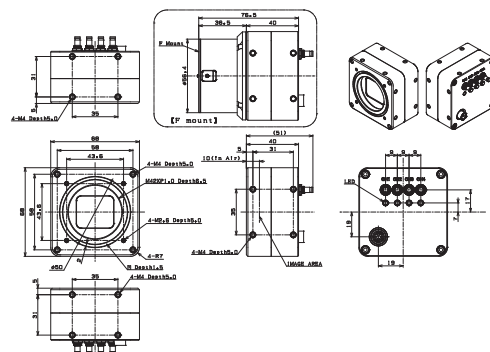

STC-CMB/CMC401CXP

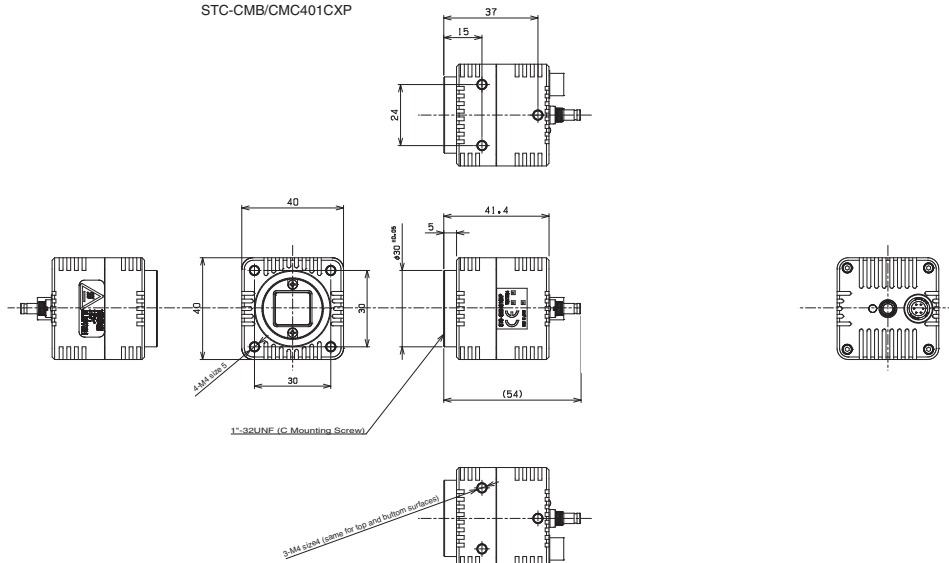

Camera Ink  
Over

## Opt-C:Link



### Description

High Speed Opt-C: Link

### Features

High FPS (93.4FPS at 12M pixel) achieved  
Cable extension, noise resistance by using optical cable

Camera Link  
Over

### Product Line-up

Model No,	Monochrome	STC-CMB120AOPT
	Color	STC-CMC120AOPT
Resolution	12M	
Frame Rate	93.4fps	
Effective Pixels	4096 × 3072	
Sensor Size	1.76	
Cell Size (HxV, μm)	5.5 × 5.5	
Sensor	CMV12000	
Lens Mount	M42, F Mount(Optional)	
General Specifications	External power supply, SFP-optical connector*2	

\*Opt-C:Link Series are scheduled to be released in December.

### Accessories

Mount Conversion Adapter		
Model No,	Applicable Model	General Specification
M42-F-R	12M Model	M42 P=1 FB=10mm → Fmount Conversion Adapter

**External Connector Specification**

External Connector Specification

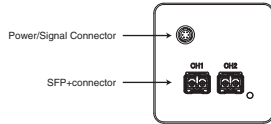

SFP+connector  
57D9AMZ (AVAGO) or equivalentx2

Channel : 2CH  
Transmission Rate : 6.25Gbps  
Transmission Mode : MultiMode  
Laser Format : 850nmVCSEL  
Laser Safety Standard : Class 1  
Connector Type : LC connector  
Cable Spec : CoreØ 50µm/62.5µm, CladØ 125µm,

Please supply power (12Vdc) from the power-I/O connector  
Please use CH1, CH2 connector with connecting cables

2 Power/Signal Connector  
HR10A-7R-6PB (Hirose) or equivalent  
Connector for power (12Vdc) , Trigger signal  
Trigger signal can be generated by camera setting  
Please use an HR10A-7P-6S (Hirose) equivalent for the cable

Pin Assignment

PIN No.	Signal Name	IN/OUT	Signal Voltage	
			LOW Voltage	HIGH Voltage
1	GND	IN		
2	SP4	IN/OUT	IN 0 ~ +0,99V	+2,3 ~ +3,6V
		OUT	0V	+3,3V
3	SP3	IN/OUT	IN 0 ~ +0,99V	+2,3 ~ +3,6V
		OUT	0V	+3,3V
4	SP2	IN/OUT	IN 0 ~ +0,99V	+2,3 ~ +3,6V
		OUT	0V	+3,3V
5	SP1	IN/OUT	IN 0 ~ +0,99V	+2,3 ~ +3,6V
		OUT	0V	+3,3V
6	+12Vdc	IN		+12Vdc



Trigger input signal can be assigned either on Opt-Click trigger packet (CC1) or on the No. 2 pin of the power/I/O connector through the camera setting communication.

**Drawing dimension**

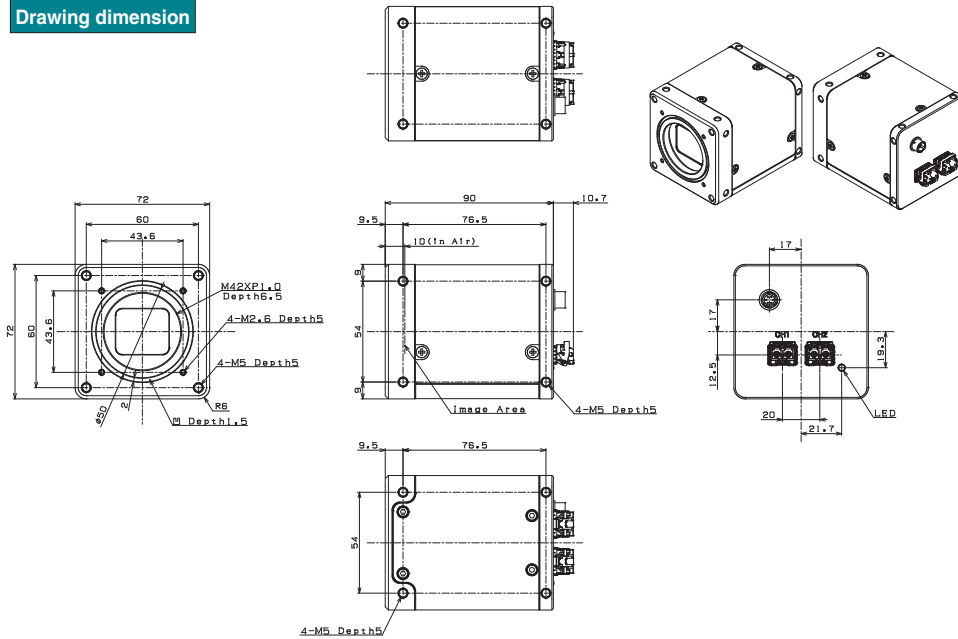

Camera link  
Over

## CameraLink CMOS



### Description

High Speed CMOS Camera Link Series

### Features

Sony CMOS [Pregius] are also available  
High resolution and high FPS implemented simultaneously  
by high performance CMOS sensor

### Product Line-up

Model	Monochrome	STC-CMB33PCL	STC-SPB43PCL	STC-SPB163PCL	STC-CMB200PCL	STC-SPB312PCL	STC-SPB322PCL
	Color	STC-CMC33PCL	STC-SPC43PCL	STC-SPC163PCL	STC-CMC200PCL	STC-SPC312PCL	STC-SPC322PCL
	NIR				STC-CMB200PCL-NIR		
Resolution		VGA	0.4M	1.6M	2M	3.2M	3.2M
Frame Rate		432fps	523.5fps	152.4fps	333fps	57.1fps	216.2fps
Effective Pixels		642 × 484	720 × 540	1440 × 1080	2048 × 1088	2048 × 1536	2048 × 1536
Sensor Size		1/3	1/2.9	1/2.9	2/3	1/1.8	1/1.8
Cell Size(HxV, μm)		7.4 × 7.4	6.9 × 6.9	3.45 × 3.45	5.5 × 5.5	3.45 × 3.45	3.45 × 3.45
Sensor		CMV300	IMX287	IMX273	CMV2000	IMX265	IMX252
Lens Mount		C	C	C	C	C	C
General Specifications		PoCL_automatically switched, SDR connector2	PoCL_automatically switched, SDR connector1	PoCL_automatically switched, SDR connector1	PoCL_automatically switched, SDR connector2	PoCL_automatically switched, SDR connector1	PoCL_automatically switched, SDR connector2

Model	Monochrome	STC-CMB401PCL	STC-APB503PCL	STC-SPB500PCL	STC-SPB510PCL	STC-SPB881PCL	STC-SPB891PCL
	Color	STC-CMC401PCL	STC-APC503PCL	STC-SPC500PCL	STC-SPC510PCL	STC-SPC881PCL	STC-SPC891PCL
	NIR	STC-CMB401PCL-NIR					
Resolution		4M	5M	5M	5M	8.9M	8.9M
Frame Rate		180fps	14fps	35.7fps	163.4fps	20.6fps	91.3fps
Effective Pixels		2048 × 2048	2592 × 1944	2448 × 2048	2448 × 2048	4096 × 2160	4096 × 2160
Sensor Size		1	1/2.5	2/3	2/3	1	1
Cell Size(HxV, μm)		5.5 × 5.5	2.2 × 2.2	3.45 × 3.45	3.45 × 3.45	3.45 × 3.45	3.45 × 3.45
Sensor		CMV4000	MT9P031	IMX264	IMX250	IMX267	IMX255
Lens Mount		C	C	C	C	C	C
General Specifications		PoCL_automatically switched, SDR connector2	PoCL_automatically switched, SDR connector1	PoCL_automatically switched, SDR connector1	PoCL_automatically switched, SDR connector2	PoCL_automatically switched, SDR connector1	PoCL_automatically switched, SDR connector2

Model	Monochrome	STC-SPB122BPCL	STC-SPB123BPCL	STC-CMB120APCL	STC-CMB120APCL-F
	Color	STC-SPC122BPCL	STC-SPC123BPCL	STC-CMC120APCL	STC-CMC120APCL-F
	NIR				
Resolution		12M	12M	12M	12M
Frame Rate		15fps	66.9fps	62.3fps	62.3fps
Effective Pixels		4096 × 3000	4096 × 3000	4096 × 3072	4096 × 3072
Sensor Size		1.1	1.1	1.76	1.76
Cell Size(HxV, μm)		3.45 × 3.45	3.45 × 3.45	5.5 × 5.5	5.5 × 5.5
Sensor		IMX304	IMX253	CMV12000	CMV12000
Lens Mount		C	C	M42 P=1 FB=10mm	F
General Specifications		PoCL_automatically switched, SDR connector1	PoCL_automatically switched, SDR connector2	PoCL_automatically switched, SDR connector2	PoCL_automatically switched, SDR connector2

\*STC-SPB/SPC42PCL, STC-SPB/SPC163PCL, STC-SPB/SPC881PCL, STC-SPB/SPC122PCL are scheduled to be released in December.



**Accessories**

Mount Conversion Adapter		
Model No.	Supported Models	General Specifications
M42-F-R	12M Model	M42 P=1 FB=10mm → Fmount Conversion Adapter

**External Connector Specification**

External Link Connectors	Camera Link connector: miniature connector (SDR) x 1, power supply I/O: HR10A-7R-6PB (Hirose) or equivalent
--------------------------	---

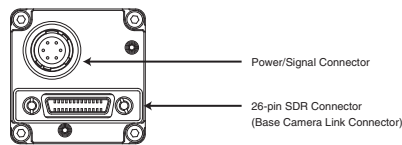

When used with the base configuration, connect the Camera Link cable to the Base connector for use.  
PoCL Available  
\*When used with Medium/Full/10tab configuration, please see the specification for applicable model

Pin Assignment

Base Camera Link Connector			
Pin No.	Signal Name	Pin No.	Signal Name
1	+12V	14	GND
2	X0-	15	X0+
3	X1-	16	X1+
4	X2-	17	X2+
5	Xclk-	18	Xclk+
6	X3-	19	X3+
7	SerTC+	20	SerTC-
8	SerTFG+	21	SerTFG-
9	CC1- (TRG)	22	CC1+ (TRG)
10	CC2+	23	CC2-
11	CC3-	24	CC3+
12	CC4+	25	CC4-
13	GND	26	+12V

Pin Assignment

Pin No.	Signal Name	IN/OUT	Signal Voltage	
			Low Voltage	High Voltage
1	GND	IN	0V	
2	SP-4	IN	0~+0.99V	+2.3~+5.0V
		OUT	0V	+3.3V
3	SP-3	IN	0~+0.99V	+2.3~+5.0V
		OUT	0V	+3.3V
4	SP-2	IN	0~+0.99V	+2.3~+5.0V
		OUT	0V	+3.3V
5	SP-1	IN	0~+0.99V	+2.3~+5.0V
		OUT	0V	+3.3V
6	+12Vdc	IN		+12Vdc

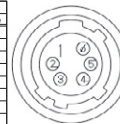

The trigger signal can be input from either one of the connectors listed below by the setting of the camera using communication  
Camera Link connector (CC1) or power supply/I/O connector (No. 2)  
\*Please use HR10A-7P-6S (Hirose) or equivalent for the cable

CameraLink

**Drawing dimension**

STC-CMB/CMC33PCL

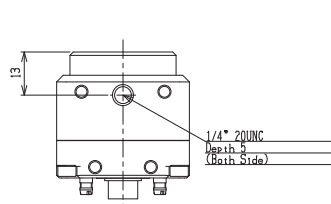
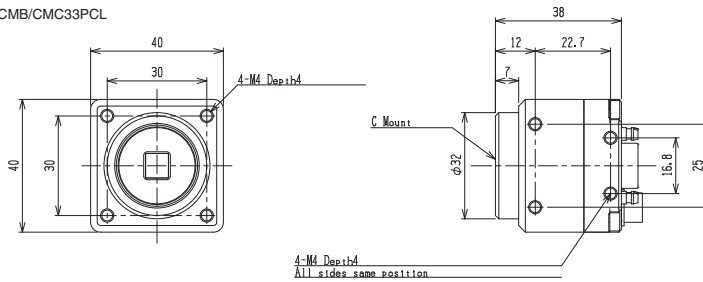

STC-CMB/CMC200PCL  
STC-CMB/CMC401PCL

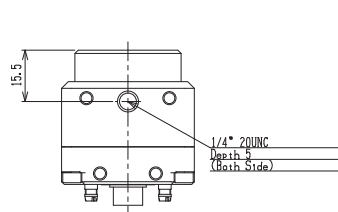
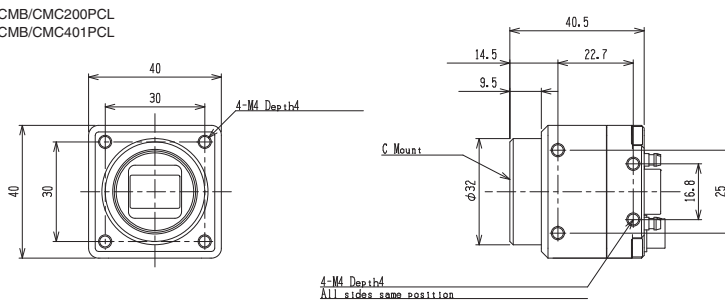

CameraLink

**Drawing dimension**

STC-APB/APC503PCL

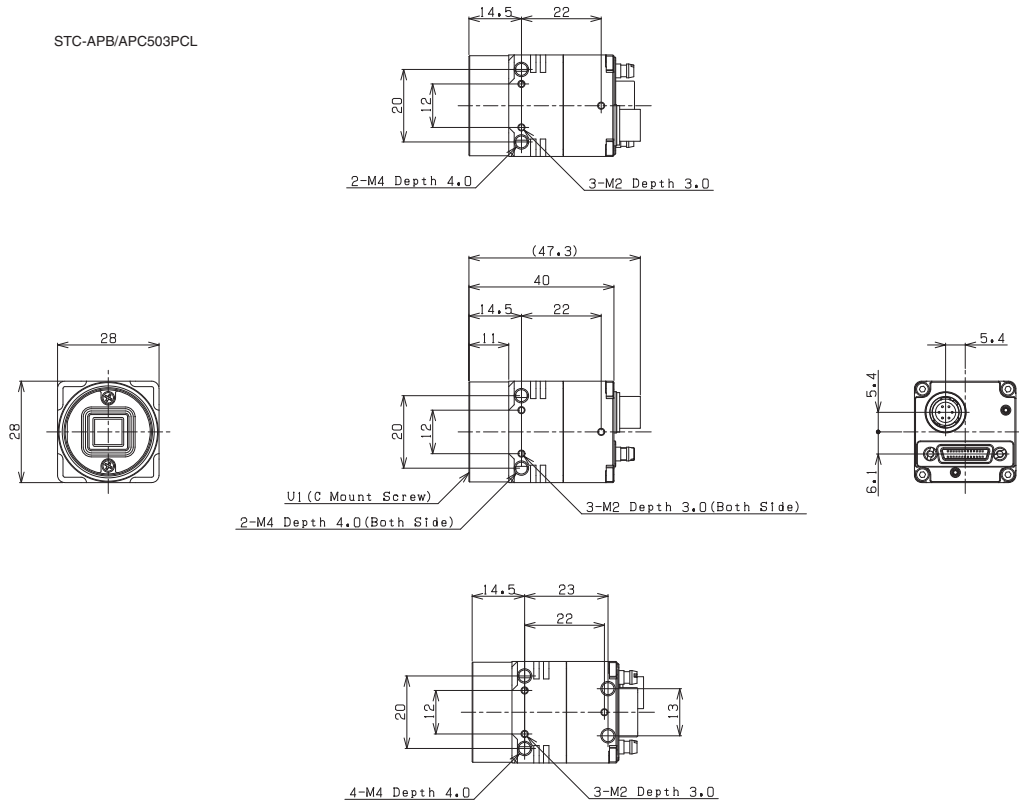

CameraLink

**Drawing dimension**

STC-SPB/SPC322PCL  
STC-SPB/SPC510PCL  
STC-SPB/SPC891PCL  
STC-SPB/SPC123BPCL

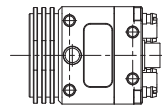
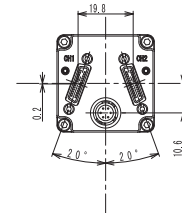
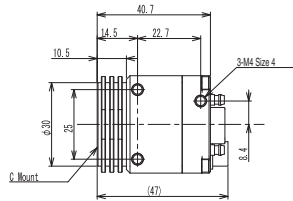
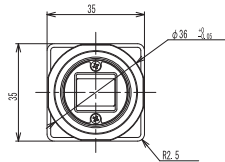
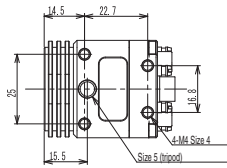
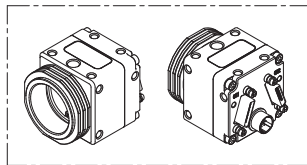

CameraLink

STC-SPB/SPC312PCL  
STC-SPB/SPC500PCL  
STC-SPB/SPC881PCL  
STC-SPB/SPC122BPCL

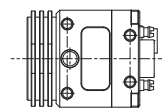
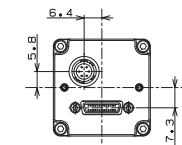
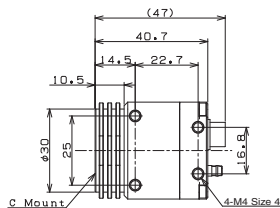
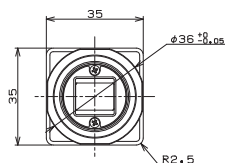
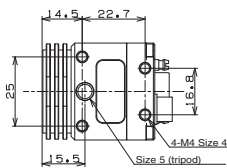
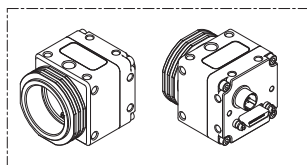

Drawing dimension

STC-CMB/CMC120APCL

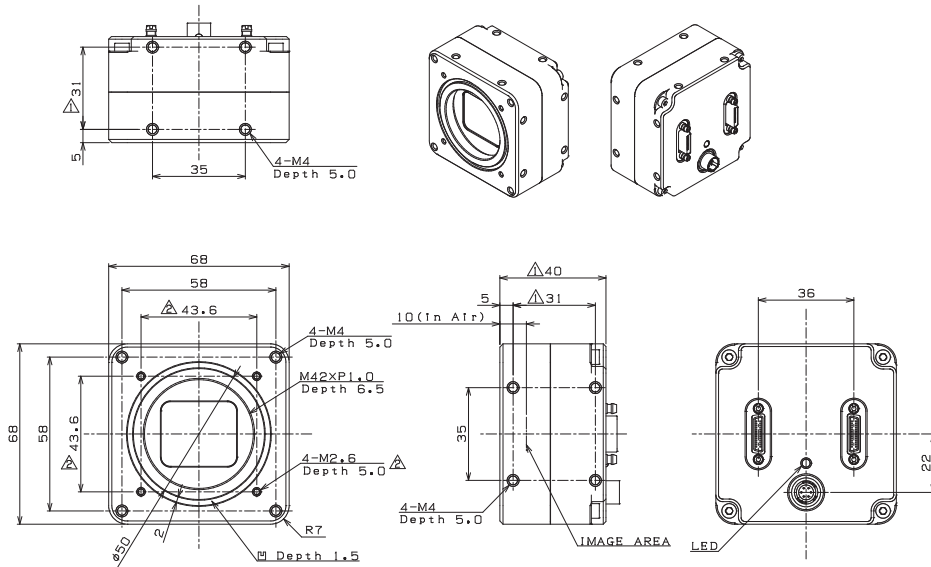

STC-CMB/CMC120APCL-F

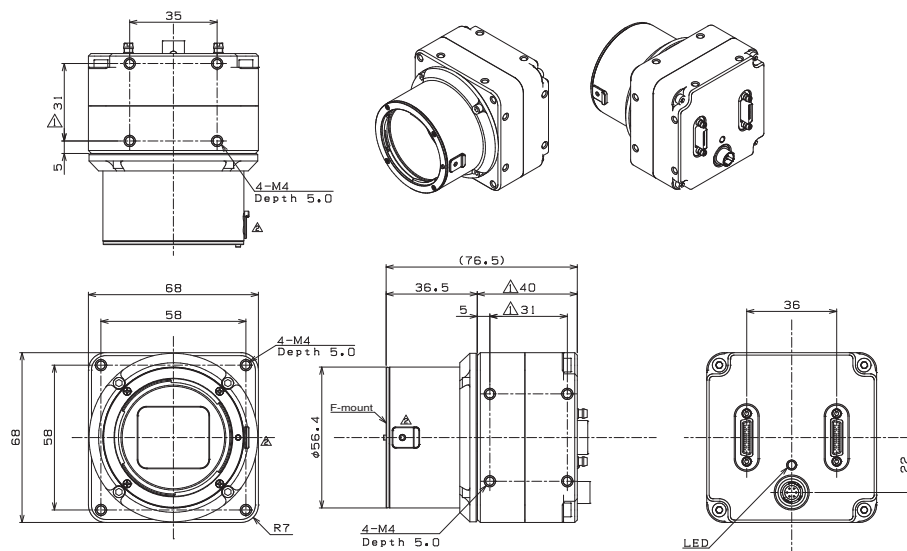

CameraLink



## HD High-Definition Camera



### Description

DVI Output Color Camera

### Features

Connectable to the monitor directly using HDMI connector enables observing system without PC. Enables a display of the crosshair and shadow masks by using the optional remote unit.

### Product Line-up

Model No.	Color	STC-HD203DV	STC-HD203DV-CS
Resolution		High-Definition 1080P	High-Definition 1080P
Frame Rate		60fps	60fps
Effective Pixels		1920 × 1080	1920 × 1080
Sensor Size		1/2.8	1/2.8
Cell Size (HxV, μm)		2.8 × 2.8	2.8 × 2.8
Sensor Type		CMOS	CMOS
Sensor		IMX136	IMX136
Lens Mount		C	CS
General Specifications		Case	Case

\*HD High-Definition Camera Series are scheduled to be released in December.

DVI/SDI

### Accessories

CS-to-C-Mount Conversion Adapter		
Model No.	Applicable Model	General Specification
CS-C-R	CS Mount Camera	

Remote Control Unit		
Model No.	Applicable Model	General Specification
RC-HD133	All DVI/SDI Camera	ø3.5 stereo pin jack

\*RC-HD133 are scheduled to be released in December.

**External Connector Specification**

External Link Connectors	HDMI connector: DVI 1.0 compliant, power supply: MP-121C (Marushin Musen Denki) equivalent, communications: e3.5 stereo pin jack
--------------------------	--

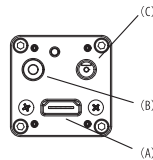

- (A) HDMI connector  
The output is DVI1.0 compliant.
- (B) e3.5 stereo pin jack for remote  
switch the connector for the configuration of  
various camera functions.
- (C) Power supply connector  
Compatible plug  
Marushin Musen Denki MP-121 or equivalent

**Drawing dimension**

STC-HD203DV

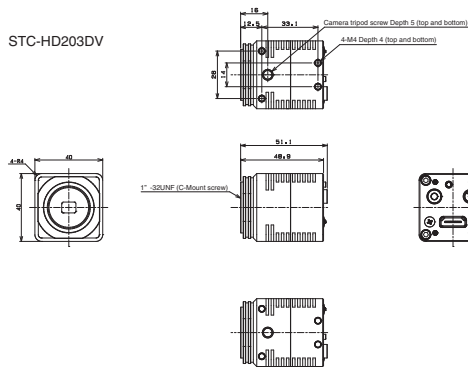

STC-HD203DV-CS

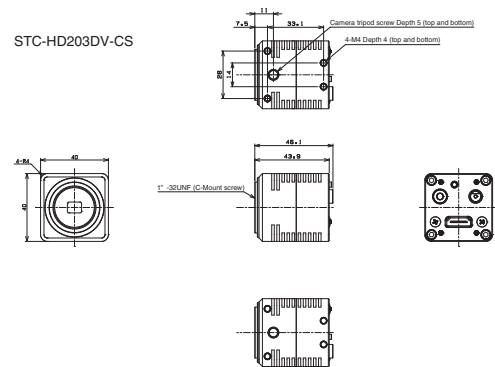

DVI/SDI

## HD-SDI HD Camera



### Description

HD-SDI Output Color Camera

### Features

Connectable to the monitor directly by versatile BNC connectors. Suitable for the long distance image transmission. Enables a display of the crosshair and shadow masks by using the optional remote unit.

### Product Line-up

Model No.	Color	STC-HD203SDI	STC-HD203SDI-CS
Resolution		High-Definition 1080P	High-Definition 1080P
Frame Rate		60fps	60fps
Effective Pixels		1920 × 1080	1920 × 1080
Sensor Size		1/2.8	1/2.8
Cell Size (HxV, μm)		2.8 × 2.8	2.8 × 2.8
Sensor Type		CMOS	CMOS
Sensor		IMX136	IMX136
Lens Mount		C	CS
General Specification		Case	Case

\*HD High-Definition Camera Series are scheduled to be released in December.

DVI/SDI

### Accessories

CS-to-C-Mount Conversion Adapter		
Model No.	Applicable Model	General Specification
CS-C-R	CS Mount Camera	

Remote Control Unit		
Model No.	Applicable Model	General Specification
RC-HD133	All DVI/SDI Camera	ø3.5 stereo pin jack

\*RC-HD133 are scheduled to be released in December.



### TV Format Small CMOS camera S133 Series



#### Description

Small Color CMOS Camera

#### Features

- Compact Size TV Format (NTSC/PAL) Camera
- Ideal for Narrow Spaces
- Variable Size Lens Mounts

#### Product Line-up

Model	Color	STC-S133N-**	STC-S133P-**
Resolution		0.65M	0.65M
Video Format		NTSC	PAL
Effective Pixels		1280 × 486	1211 × 576
Sensor Size		1/3.2	1/3.2
Cell Size(HxV, μm)		3.5 × 3.5	3.5 × 3.5
Sensor		ISX017	ISX017

\*Please select one among above when you order

#### Line-up

Model	Monochrome/Color	Sensor Size	Mount	Video Format	General Specification
STC-S133N	Color	1/3.2	Base(Without lens mount)	NTSC	
STC-S133N-L			Fixed Lens		
STC-S133N-CS			CS		
STC-S133P			Base(Without lens mount)	PAL	
STC-S133P-L			Fixed Lens		
STC-S133P-CS			CS		

\*STC-S133 Series are scheduled to be released in December.

Color TV Format



### Line Scanning Camera CameraLink Model



#### Description

Camera Link Line Scan Camera

#### Features

- A Large Variety of Line-up from 2K to 8K
- Single/Dual Line Camera
- Easy to Attach in Small Sapces

#### Product Line-up

Model	Monochrome	FS-B2KU7CLU-C	FS-B2KU7CLU-F	FS-B2KU7CLU-M42	FS-B4KU7CLU-F	FS-B4KU7CLU-M42	FS-B4KU35CLU-C
	Color						
Resolution		2048 × 1	2048 × 1	2048 × 1	4096 × 1	4096 × 1	4096 × 1
Line Rate		80KHz	80KHz	80KHz	80KHz	80KHz	80KHz
Pixel size		7um	7um	7um	7um	7um	3.5um
Sensor		CMOS	CMOS	CMOS	CMOS	CMOS	CMOS
Sensor Type		Shingle	Shingle	Shingle	Shingle	Shingle	Shingle
Mount		C	F	M42	F	M42	C
General Specifications		MDRx2	MDRx2	MDRx2	MDRx2	MDRx2	MDRx2

Model	Monochrome	FS-B4KU35CLU-F	FS-B4KU35CLU-M42	FS-B8KU7CLU-M72	FS-B8KU35CLU-F	FS-B8KU35CLU-M42	FS-B16KU35CLU-M72
	Color						
Resolution		4096 × 1	4096 × 1	8192 × 1	8192 × 1	8192 × 1	16384 × 1
Line Rate		80KHz	80KHz	80KHz	80KHz	80KHz	40KHz
Pixel size		3.5um	3.5um	7um	3.5um	3.5um	3.5um
Sensor		CMOS	CMOS	CMOS	CMOS	CMOS	CMOS
Sensor Type		Shingle	Shingle	Shingle	Shingle	Shingle	Shingle
Mount		F	M42	M72	F	M42	M72
General Specifications		MDRx2	MDRx2	MDRx2	MDRx2	MDRx2	MDRx2

Model	Monochrome	FS-B2KU7DCLU-C	FS-B4KU7DCLU-F	FS-B4KU7DCLU-M42	FS-B8KU7DCLU-M72	FS-B2KU7DCLU-F	FS-B2KU7DCLU-M42
	Color	FS-C2KU7DCLU-C				FS-C2KU7DCLU-F	FS-C2KU7DCLU-M42
Resolution		2048 × 2	4096 × 2	4096 × 2	8192 × 2	2048 × 2	2048 × 2
Line Rate		160KHz/80KHz	160KHz	160KHz	160KHz	160KHz/80KHz	160KHz/80KHz
Pixel size		7um	7um	7um	7um	7um	7um
Sensor		CMOS	CMOS	CMOS	CMOS	CMOS	CMOS
Sensor Type		Dual	Dual	Dual	Dual	Dual	Dual
Mount		C	F	M42	M72	F	M42
General Specifications		MDRx2	MDRx2	MDRx2	MDRx2	MDRx2	MDRx2

\*Line Scanning Camera CameraLink Series are scheduled to be released in December.

Line Scanning Camera

Model	Monochrome	FS-C4KU7DCLU-F	FS-C4KU7DCLU-M42	FS-C8KU7DCLU-M72
	Color			
Resolution		4096 × 2	4096 × 2	8192 × 2
Line Rate		80KHz	80KHz	40KHz
Pixel size		7um	7um	7um
Sensor		CMOS	CMOS	CMOS
Sensor Type		Dual	Dual	Dual
Mount		F	M42	M72
General Specifications		MDRx2	MDRx2	MDRx2

**External Connector Specification**

External Connectors	Camera Link Connector:MDR,Power supply:HR10A-7R-6PB(Hirose) or equivalent
---------------------	---

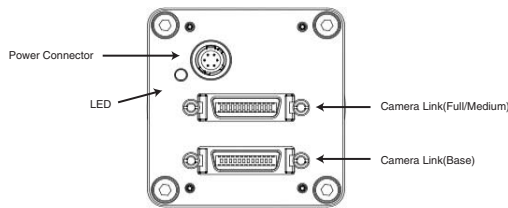

Pin No.	Signal name	IN/OUT	Voltage
1	+12V	IN	+12V
2	+12V	IN	+12V
3	+12V	IN	+12V
4	GND		
5	GND		
6	GND		

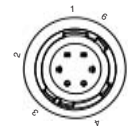

\*Please use HR10A-7P-6S or equivalent for the cable  
 \*Differed by models. Please see below specifications.

Line Scanning  
Camera



**Drawing dimension**

C Mount Type

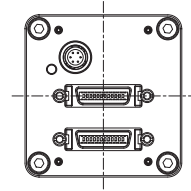
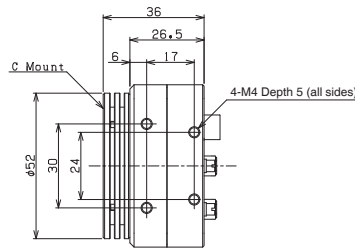
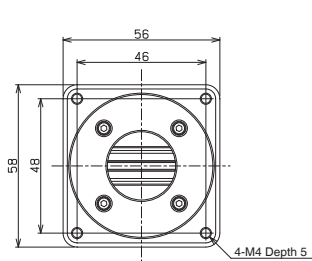
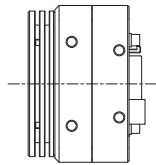
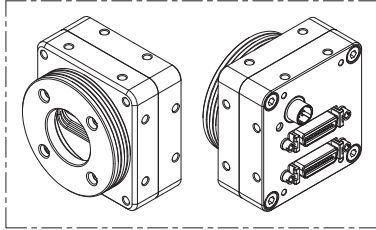

Line Scanning  
 Camera

F Mount Type

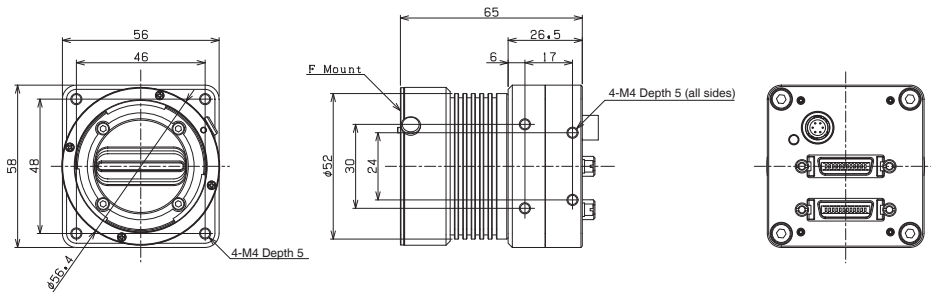
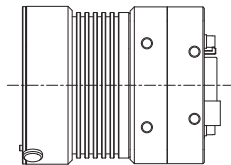
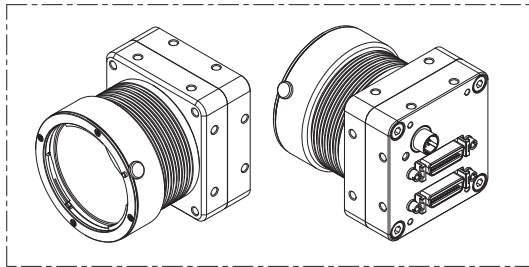

M42 Mount Type

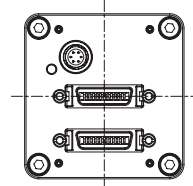
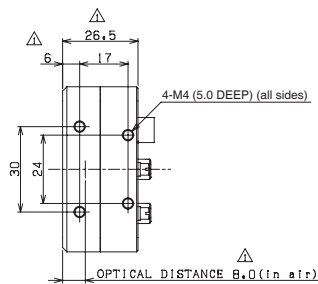
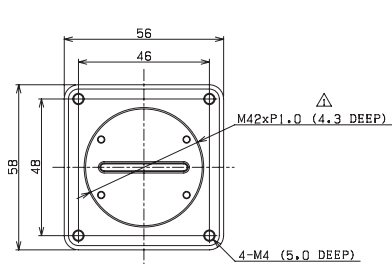
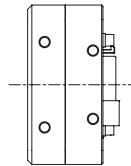
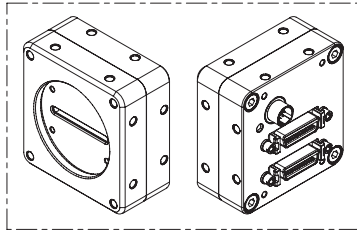

Line Scanning  
Camera

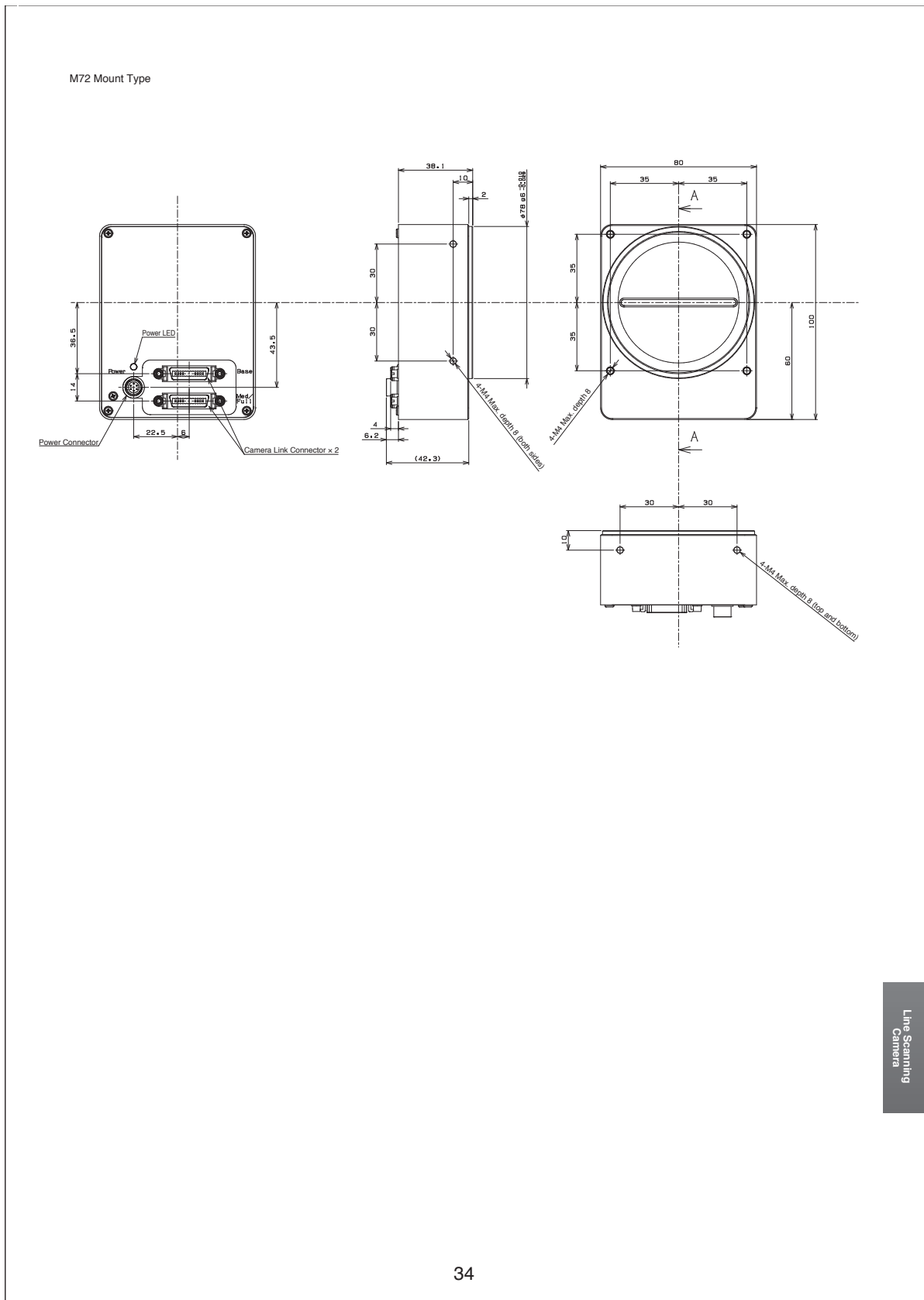

Line Scanning  
 Camera

**Accessory ,Cable, others**



**Description**

Optional items for using cameras cables are arranged

**Screw-fastened USB3.0 Cable**



Model No.	Applicable Model	General Specification
NU3MBASU3S-2m	All USB3.0 Cameras	2m, USB 3.0 MicroB, with camera-side fastening screws
NU3MBASU3S-3.5m	All USB3.0 Cameras	3.5m, USB 3.0 MicroB, with camera-side fastening screws
NU3MBASU3B-2m	All USB3.0 Cameras	2m, USB 3.0 MicroB, with camera-side fastening screws, robot cables
NU3MBASU3B-3.5m	All USB3.0 Cameras	3.5m, USB 3.0 MicroB, with camera-side fastening screws, robot cables

\*Please make sure that USB 3.0 cables operate correctly under your environment beforehand

Mount Conversion Adapter



Adapter ring necessary when using C-mount lens with CS-mount camera  
Converting adapter from M42 P=1 FB=10mm to F-mount

Model No.	Applicable Model	General Specification
CS-C-R	CS-Mount Model	CS Mount Model
M42-F-R	12M	M42 P=1 FB=10mm →F mount conversion adapter

Tripod Mount



Optional adapter for fastening the camera with tripod screws

Model No.	Applicable Model	General Specification
TP-JVA	Except for STC-MCE/MBE132U3V, STC-MBA/MCA5MUSB	

\*TP-JVA is scheduled to be released in December.

Remote Control Unit



The unit is connected to the pin jack on the back of the camera allowing various settings to be made with an on-screen display

Model No.	Applicable Model	General Specification
RC-HD133	All DVI/SDI models	ø3.5 stereo pin jack
RC-S133	S133 Series	

\*RC-HD133,RC-S133 are scheduled to be released in December.

Communication jig from PC



The jig is connected to the pin jack on the back of the camera allowing various settings to be made using a PC.

Model No.	Applicable Model	Communication Software	General Specification
JIG-USB-HD	All DVI/SDI Model	JTACtrl	ø3.5 stereo pin jack-USB miniB
		HD133Ctrl	

\*JIG-USB-HD is scheduled to be released in December.

## Spectral Characteristics Chart

This is the Spectral Characteristics Chart of the image sensor (CMOS) published in this catalog

	Model No.	Type	Page
1	IMX287	Monochrome	38
2	IMX273	Monochrome	38
3	IMX174	Monochrome	39
4	IMX249	Monochrome	39
5	IMX265	Monochrome	39
6	IMX252	Monochrome	39
7	IMX264	Monochrome	40
8	IMX250	Monochrome	40
9	IMX267	Monochrome	40
10	IMX255	Monochrome	40
11	IMX304	Monochrome	41
12	IMX253	Monochrome	41
13	CMV300	Monochrome	42
14	CMV2000	Monochrome	42
15	CMV4000	Monochrome	42
16	CMV12000	Monochrome	43
17	MT9P031	Monochrome	44
18	MT9J003	Monochrome	44
19	EV76C560ACT	Monochrome	43
20	CMV2000	NIR	43
21	CMV4000	NIR	43

	Model No.	Type	Page
22	IMX287	Color	38
23	IMX273	Color	38
24	IMX174	Color	39
25	IMX249	Color	39
26	IMX265	Color	39
27	IMX252	Color	39
28	IMX264	Color	40
29	IMX250	Color	40
30	IMX267	Color	40
31	IMX255	Color	40
32	IMX304	Color	41
33	IMX253	Color	41
34	IMX274	Color	41
35	IMX226	Color	41
36	ISX017	Color	42
37	IMX136	Color	42
38	CMV300	Color	42
39	CMV2000	Color	42
40	CMV4000	Color	42
41	CMV12000	Color	43
42	MT9P031	Color	44
43	EV76C560ACT	Color	43

**IMX287**

1/2.9" CMOS 0.4M Monochrome

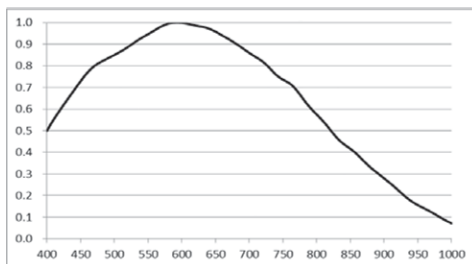

**IMX287**

1/2.9" CMOS 0.4M Color

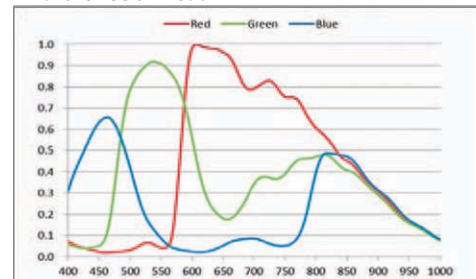

**IMX273**

1/2.9" CMOS 1.6M Monochrome

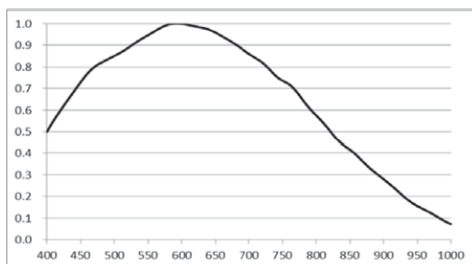

**IMX273**

1/2.9" CMOS 1.6M Color

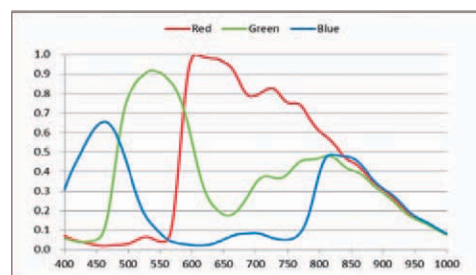



**IMX174, IMX249**

1/1.2" CMOS 2.3M Monochrome

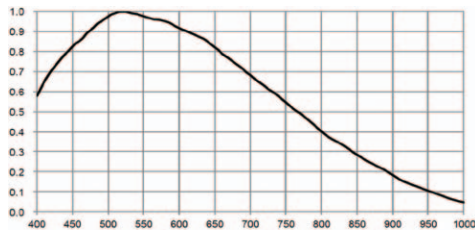

**IMX174, IMX249**

1/1.2" CMOS 2.3M Color

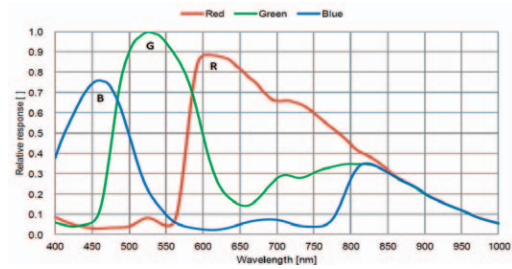

**IMX265, IMX252**

1/1.8" CMOS 3.2M Monochrome

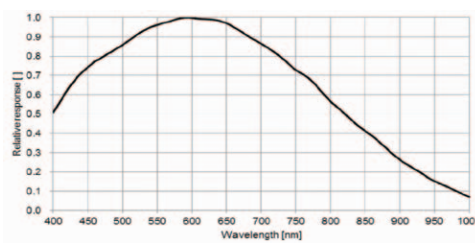

**IMX265, IMX252**

1/1.8" CMOS 3.2M Color

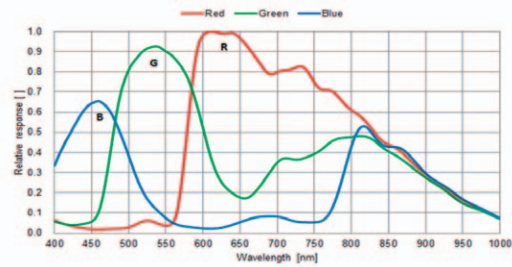

**IMX264, IMX250**

2/3" CMOS 5M Monochrome

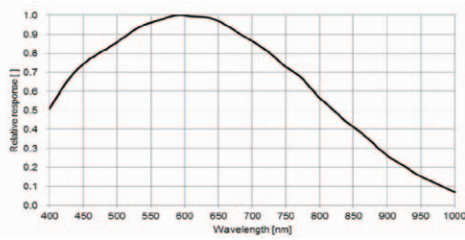

**IMX264, IMX250**

2/3" CMOS 5M Color

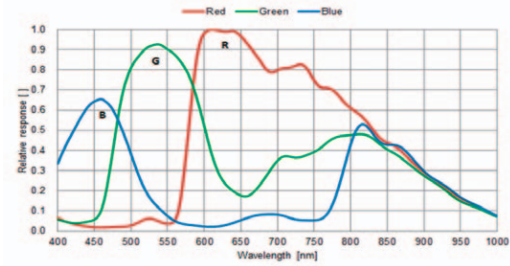

**IMX267-IMX255**

1" CMOS 8.9M Monochrome

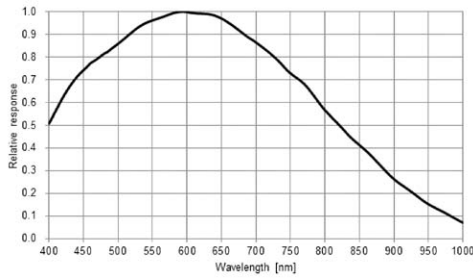

**IMX267-IMX255**

1" CMOS 8.9M Color

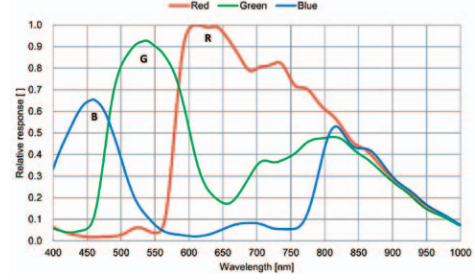

**IMX304-IMX253**

1.1" CMOS 12M Monochrome

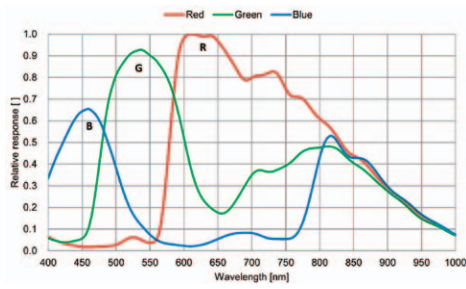

**IMX304-IMX253**

1.1" CMOS 12M Color

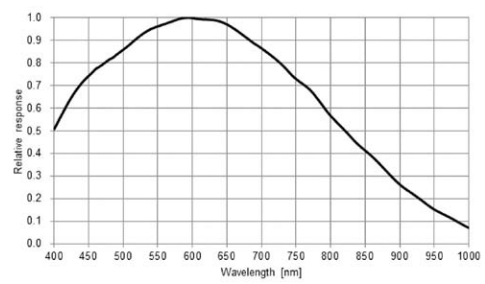

**IMX274**

1/2.5" CMOS 8.3M Color

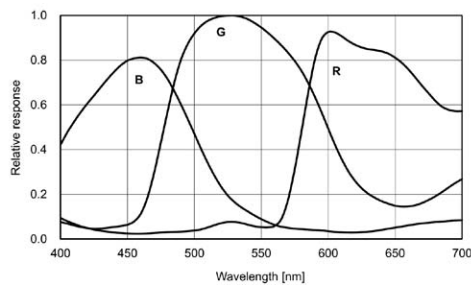

**IMX226**

1/1.7" CMOS 12M Color

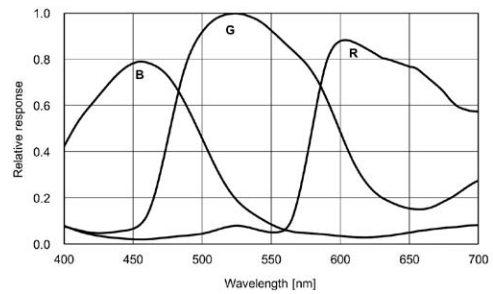

**ISX017**

1/3.2" CMOS 0.6M Color

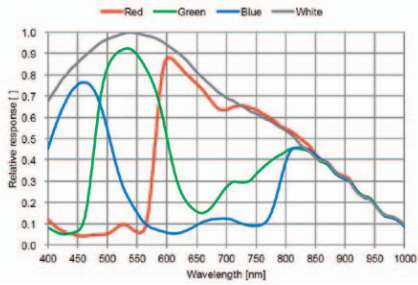

**IMX136**

1/2.8" CMOS 1080P FULL High-definition Color

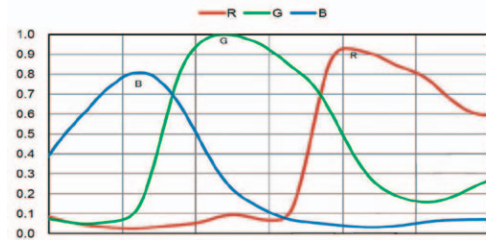

**CMV300**

**CMV300**

1/3" CMOS VGA Monochrome, Color

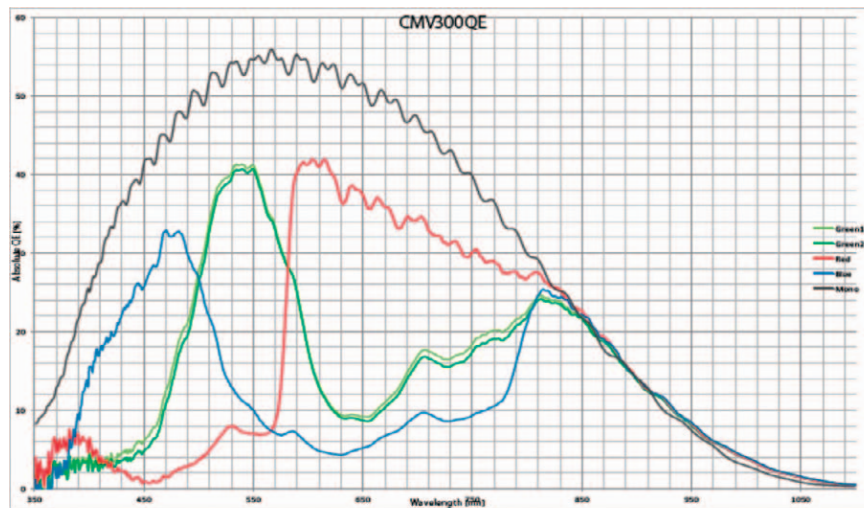

**CMV2000-CMV4000**

2/3" CMOS 2M Monochrome-1" CMOS 4M Monochrome

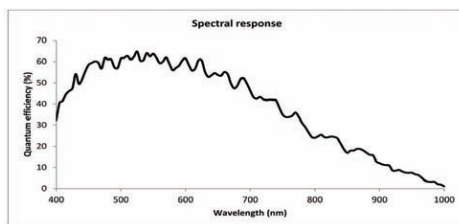

**CMV2000-CMV4000**

2/3" CMOS 2M Color-1" CMOS 4M Color

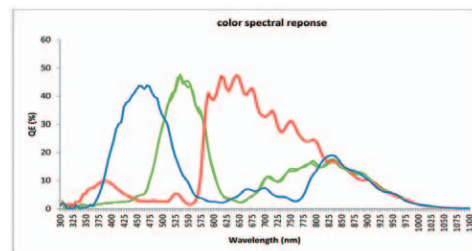

Accessories

**CMV2000-CMV4000**

2/3" CMOS 2M NIR-1" CMOS 4M NIR

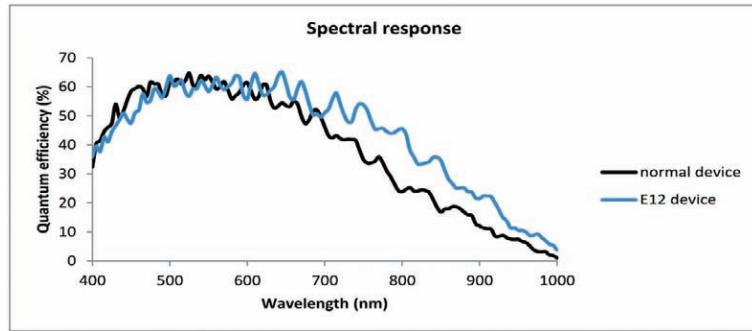

**CMV12000**

**CMV12000**

1.76" CMOS 12M Monochrome, Color

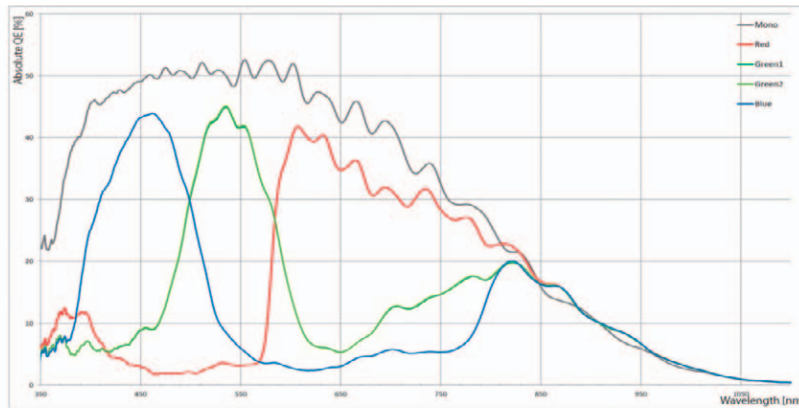

**EV76C560ACT**

**EV76C560ACT**

1/1.8" CMOS 1.3M Monochrome, Color

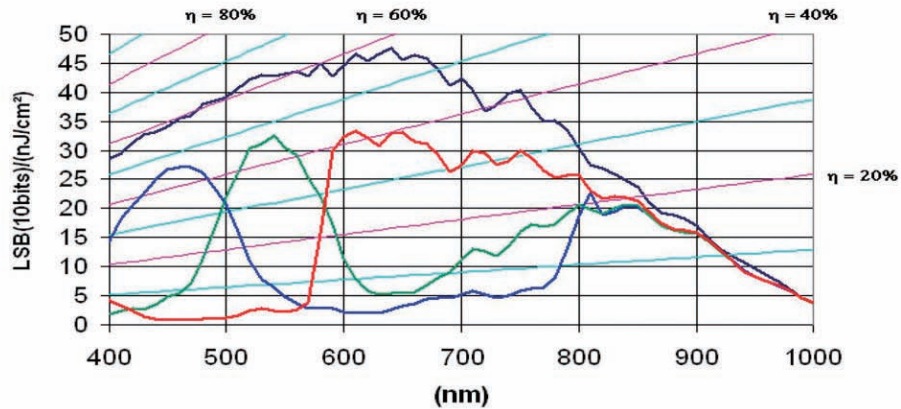

Accessories

**MT9P031**

1/2.5" CMOS 5M Monochrome

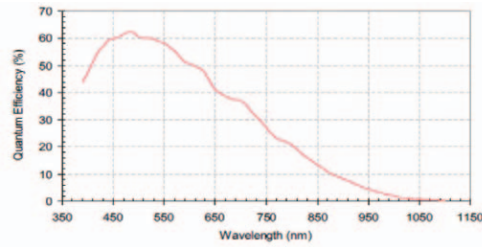

**MT9P031**

1/2.5" CMOS 5M Color

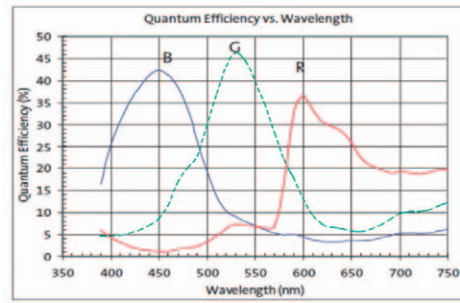

**MT9J003**

1/2.3 CMOS 10M Monochrome

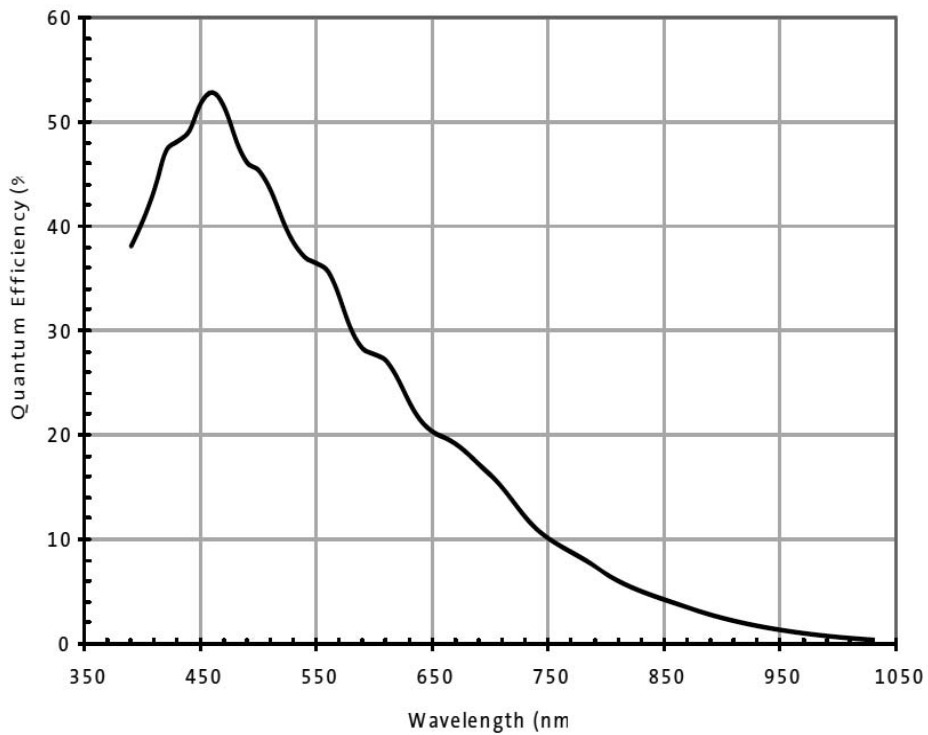





## Terms and Conditions Agreement

### Read and understand this catalog.

Please read and understand this catalog before purchasing the products. Please consult your OMRON representative if you have any questions or comments.

### Warranties.

- (a) Exclusive Warranty. Omron's exclusive warranty is that the Products will be free from defects in materials and workmanship for a period of twelve months from the date of sale by Omron (or such other period expressed in writing by Omron). Omron disclaims all other warranties, express or implied.
- (b) Limitations. OMRON MAKES NO WARRANTY OR REPRESENTATION, EXPRESS OR IMPLIED, ABOUT NON-INFRINGEMENT, MERCHANTABILITY OR FITNESS FOR A PARTICULAR PURPOSE OF THE PRODUCTS. BUYER ACKNOWLEDGES THAT IT ALONE HAS DETERMINED THAT THE PRODUCTS WILL SUITABLY MEET THE REQUIREMENTS OF THEIR INTENDED USE.

Omron further disclaims all warranties and responsibility of any type for claims or expenses based on infringement by the Products or otherwise of any intellectual property right. (c) Buyer Remedy. Omron's sole obligation hereunder shall be, at Omron's election, to (i) replace (in the form originally shipped with Buyer responsible for labor charges for removal or replacement thereof) the non-complying Product, (ii) repair the non-complying Product, or (iii) repay or credit Buyer an amount equal to the purchase price of the non-complying Product; provided that in no event shall Omron be responsible for warranty, repair, indemnity or any other claims or expenses regarding the Products unless Omron's analysis confirms that the Products were properly handled, stored, installed and maintained and not subject to contamination, abuse, misuse or inappropriate modification. Return of any Products by Buyer must be approved in writing by Omron before shipment. Omron Companies shall not be liable for the suitability or unsuitability or the results from the use of Products in combination with any electrical or electronic components, circuits, system assemblies or any other materials or substances or environments. Any advice, recommendations or information given orally or in writing, are not to be construed as an amendment or addition to the above warranty.

See <http://www.omron.com/global/> or contact your Omron representative for published information.

### Limitation on Liability; Etc.

OMRON COMPANIES SHALL NOT BE LIABLE FOR SPECIAL, INDIRECT, INCIDENTAL, OR CONSEQUENTIAL DAMAGES, LOSS OF PROFITS OR PRODUCTION OR COMMERCIAL LOSS IN ANY WAY CONNECTED WITH THE PRODUCTS, WHETHER SUCH CLAIM IS BASED IN CONTRACT, WARRANTY, NEGLIGENCE OR STRICT LIABILITY.

Further, in no event shall liability of Omron Companies exceed the individual price of the Product on which liability is asserted.

### Suitability of Use.

Omron Companies shall not be responsible for conformity with any standards, codes or regulations which apply to the combination of the Product in the Buyer's application or use of the Product. At Buyer's request, Omron will provide applicable third party certification documents identifying ratings and limitations of use which apply to the Product. This information by itself is not sufficient for a complete determination of the suitability of the Product in combination with the end product, machine, system, or other application or use. Buyer shall be solely responsible for determining appropriateness of the particular Product with respect to Buyer's application, product or system. Buyer shall take application responsibility in all cases.

NEVER USE THE PRODUCT FOR AN APPLICATION INVOLVING SERIOUS RISK TO LIFE OR PROPERTY OR IN LARGE QUANTITIES WITHOUT ENSURING THAT THE SYSTEM AS A WHOLE HAS BEEN DESIGNED TO ADDRESS THE RISKS, AND THAT THE OMRON PRODUCT(S) IS PROPERLY RATED AND INSTALLED FOR THE INTENDED USE WITHIN THE OVERALL EQUIPMENT OR SYSTEM.

### Programmable Products.

Omron Companies shall not be responsible for the user's programming of a programmable Product, or any consequence thereof.

### Performance Data.

Data presented in Omron Company websites, catalogs and other materials is provided as a guide for the user in determining suitability and does not constitute a warranty. It may represent the result of Omron's test conditions, and the user must correlate it to actual application requirements. Actual performance is subject to the Omron's Warranty and Limitations of Liability.

### Change in Specifications.

Product specifications and accessories may be changed at any time based on improvements and other reasons. It is our practice to change part numbers when published ratings or features are changed, or when significant construction changes are made. However, some specifications of the Product may be changed without any notice. When in doubt, special part numbers may be assigned to fix or establish key specifications for your application. Please consult with your Omron's representative at any time to confirm actual specifications of purchased Product.

### Errors and Omissions.

Information presented by Omron Companies has been checked and is believed to be accurate; however, no responsibility is assumed for clerical, typographical or proofreading errors or omissions.



Note: Do not use this document to operate the Unit.

<p><b>OMRON Corporation Industrial Automation Company</b> Kyoto, JAPAN Contact: <a href="http://www.ia.omron.com">www.ia.omron.com</a></p> <p><i>Regional Headquarters</i> <b>OMRON EUROPE B.V.</b> <b>Sensor Business Unit</b> Carl-Benz-Str. 4, D-71154 Nufringen, Germany Tel: (49) 7032-811-0/Fax: (49) 7032-811-199</p> <p><b>OMRON ASIA PACIFIC PTE. LTD.</b> No. 438A Alexandra Road # 05-05/08 (Lobby 2), Alexandra Technopark, Singapore 119967 Tel: (65) 6835-3011/Fax: (65) 6835-2711</p>	<p><b>OMRON ELECTRONICS LLC</b> 2895 Greenspoint Parkway, Suite 200 Hoffman Estates, IL 60169 U.S.A. Tel: (1) 847-843-7900/Fax: (1) 847-843-7787</p> <p><b>OMRON (CHINA) CO., LTD.</b> Room 2211, Bank of China Tower, 200 Yin Cheng Zhong Road, PuDong New Area, Shanghai, 200120, China Tel: (86) 21-5037-2222/Fax: (86) 21-5037-2200</p>	<p><b>Authorized Distributor:</b></p> <div style="border: 1px solid black; height: 100px; width: 100%;"></div> <p>© OMRON Corporation 2017 All Rights Reserved. In the interest of product improvement, specifications are subject to change without notice. <b>CSM_1_2_1217</b> <b>Cat. No. Q259-E1-01</b> 1117(1117)</p>
--	---	--